

Final Conference – Project BIORETE

- The German Experience on Bio methane Grid injection -

Torsten Fischer and Dr Katharina Backes

Krieg & Fischer Ingenieure GmbH
Bertha-von-Suttner-Strasse 9, 37085 Göttingen
Tel.: +49 551 900 363-0, Fax: +49 551 900 363-29
Fischer@KriegFischer.de
www.KriegFischer.de

Milan, November 17, 2010

Krieg & Fischer Ingenieure GmbH

Engineering Office, specialized in Design and Engineering of Biogas Plants

Foundation: 1999

Team: 23

Experience: > 25 Years

References: ca. 150 Biogas Plants

in: Germany, Japan, Netherlands, Austria, Switzerland, Lithuania, Italy, Slovakia, Canada, USA, Spain, France, Ireland

Partner: Japan, Korea, USA, Canada, Bulgaria, France, Hungary, Turkey, Poland, Italy Spain, Ireland, Serbia and Greece

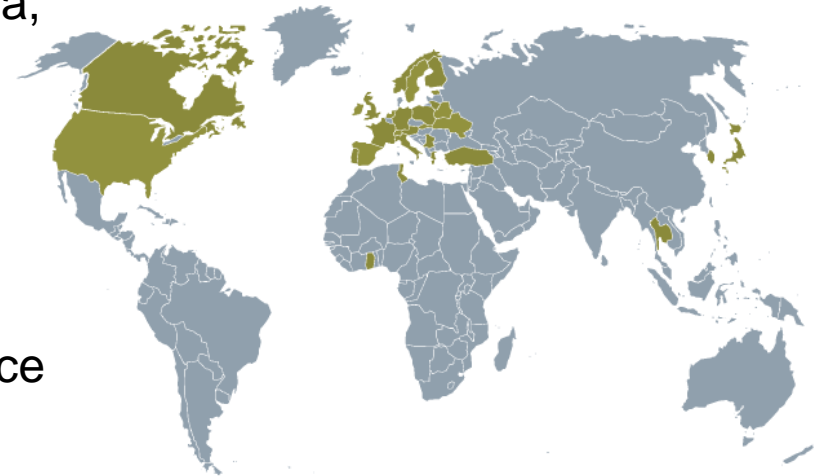
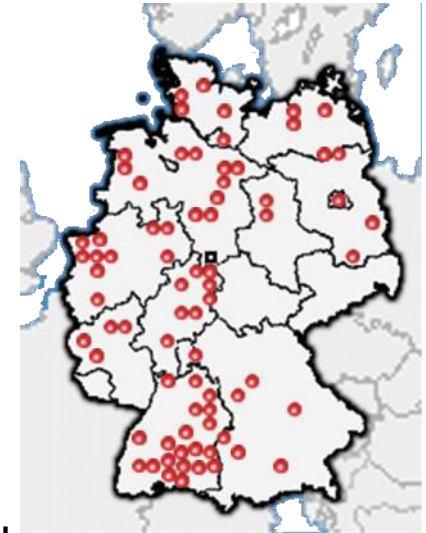

Service offerings of Krieg & Fischer in the field of Biogas

- Studies
- Concept Development
- Calculations
- Permits & Approvals
- Engineering
- Tendering and Commissioning
- Construction
- Start-up
- Optimization/Retrofits
- Supervision and Consulting

References - Examples



Central Biogas Plant



Energy Crop Biogas Plant



Kitchen Waste Digestion

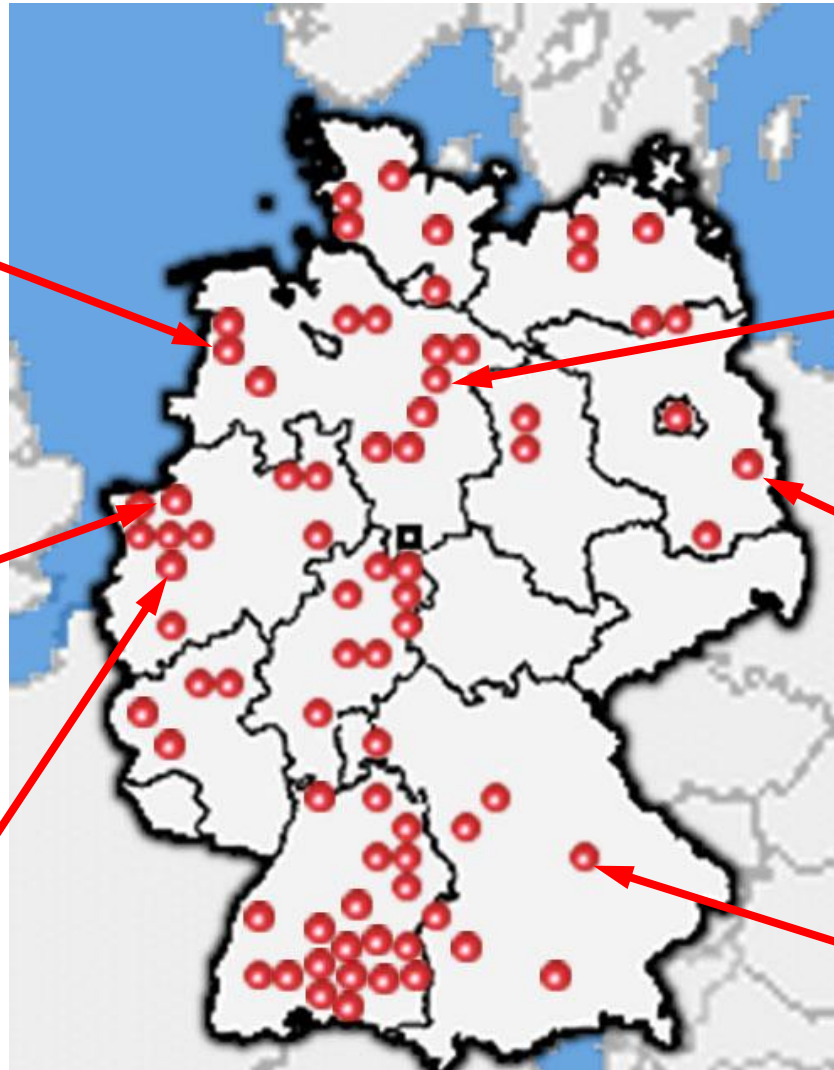

Potato Residue Digestion



Energy Crops with Cattle Manure



Biowaste Digestion

References in Italy

Prato allo Stelvio 2001



- Boldini, study 2002
- Brentonico, study 2002
- Schluderns, preplanning 2001
- Terenten, study 2001
- Forni di Sopra, study 1999

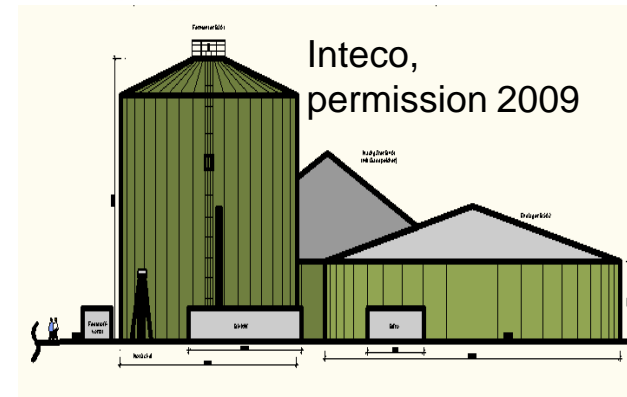

Bosco della Cascina, 2009



Forcate 2009

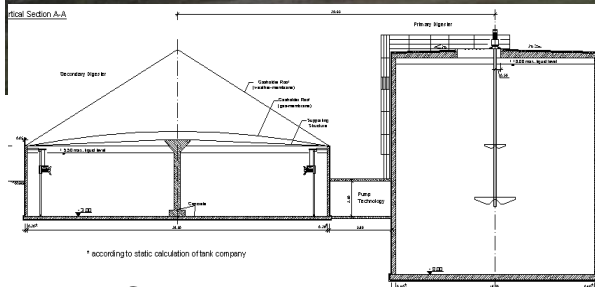

Bio Canali 2007, permission planning

Our partner in Italy:
INTE.CO. Engineering S.R.L.
 Via Castelfranco Veneto 79/1
 33170 Pordenone, Italy
 Phone: +39 (0434) 365126
 Mail: pia@intecoeng.it
<http://www.intecoeng.it>

German biogas feed-in projects



Development of biogas feed-in projects

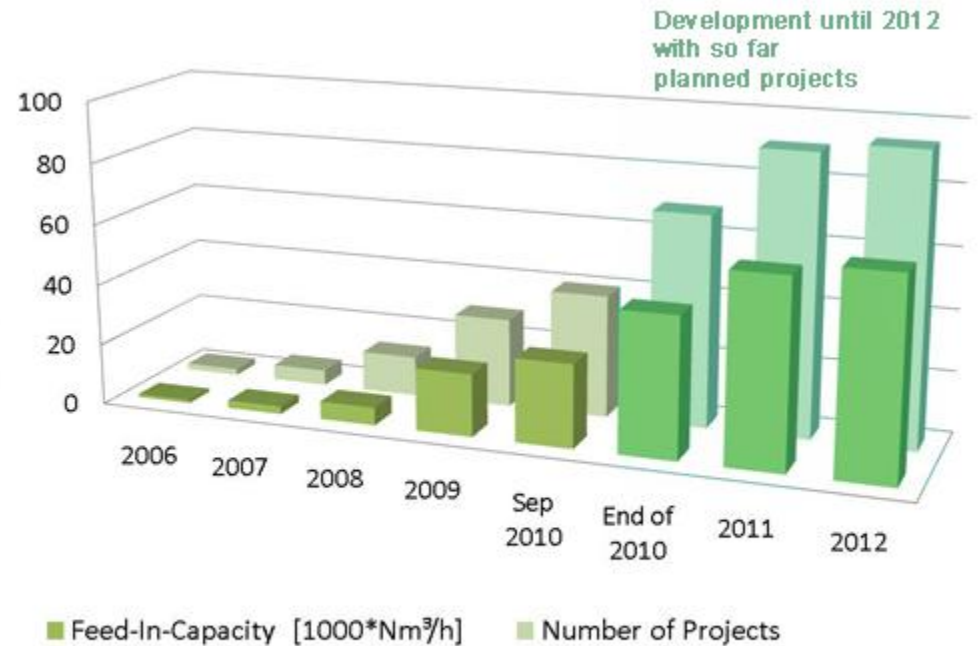

German Energy-Agency (dena)
September 2010

Planned and installed German biogas feed-in projects
Source: dena Deutsche Energieagentur

Biogas concepts

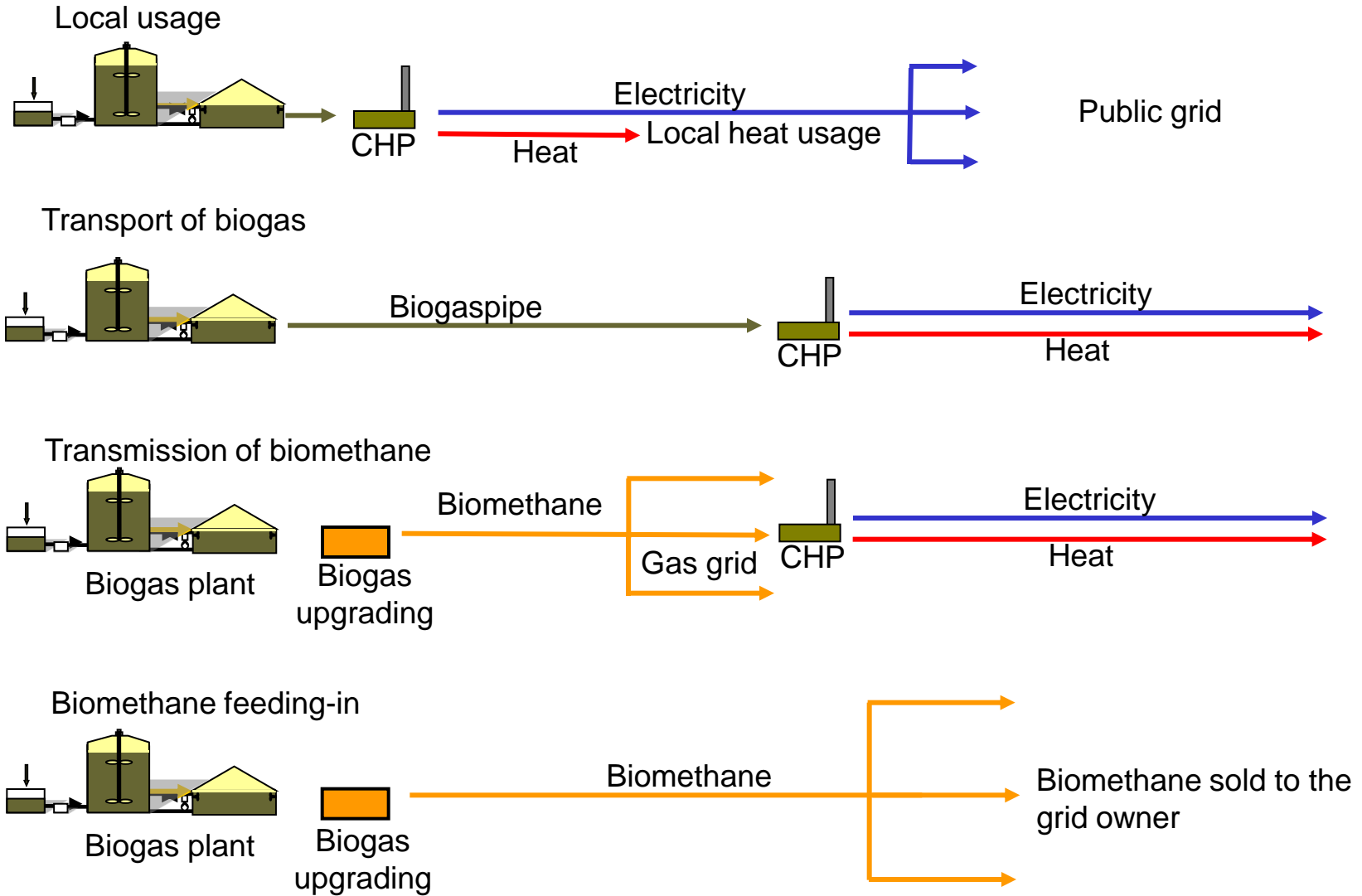

Pliening (Schmack), Germany



First biogas plant with upgrading system in Germany.

Till now there are about **40 plants** with upgrading systems in Germany.

- Built: 2006 by Schmack
- Input: energy crops 32-35.000 t/a
- Biogas upgrading system (pressure swing adsorption, PSA):
- 3,900,000 m³/Jahr (485 m³/h)

Comparison of power input and gas feed-in

Electricity	Bio methane
Renewable Energy Source Act (EEG)	GasNZV: German ordinance on gas grid access
Fixed amount of money depending on the EEG categories	Price has to be negotiated with the grid owner
Net owner is responsible for transformation	Grid owner is responsible for pressure increase, odoration, adjustment...
Transmission possible	Transmission possible

Biogas injection

In Germany there are 5 different areas of natural gas quality.

- Biogas has to be upgraded to the specifications according to different conditions:
 - Characteristics as Wobbe index, density, heating value and lower heating value
 - Different components (CH_4 , CO_2 , trace gases, O_2 ...)
 - Dew point water, dew point hydrocarbon
- To adjust the injected bio methane, it has to be mixed with:
 - Liquid gas (increase Wobbe-index)
 - Air (decrease Wobbe-index)

Injection to the national gas grid



Conditioning of the bio methane to adapt it to the local quality of the natural gas

- Measurement gas quality
- Odoration
- Adaption of heating value

Gasnetzzugangsverordnung (GasNZV) German ordinance on gas grid access



- Executive order for the liberalization of the German gas market
- Decree for the free access to the gas grid (opening of the gas market)
- Special part about preferential injection of biogas

Ambition aim is to increase bio methane injection to 6.000.000.000 m³ per year till 2020

Ratification 2005, 2nd revised form 2010

Gasnetzzugangsverordnung (GasNZV) German ordinance on gas grid access



- **The grid operator has to pay 75% of the connection costs**
- The grid operator is responsible and has to pay for operation and maintenance of the grid connection
- The grid operator has to guarantee a 96%-availability of the grid
- **Preferential gas injection of bio methane**
- The grid operator has to increase the capacity of the gas grid if necessary (reasonable economic)
- **The maximal methane emission has to be lower than 0,5% and will be reduced to 0,2% after 2012.**
- The grid operator is responsible for the addition of odorants and measurement of the gas composition

Interfaces biogas upgrading



Abbildung 1-4: Einspeiseschnittstellen und relevantes Regelwerk [6]

Technical Requirements

Biogas plants with upgrading system have to fulfill the requirements defined in the regulations of DVGW

- Special building materials have to be used.
→ PVC is not allowed for gas pipes.
But about 80 to 90% of all biogas plant suppliers use PVC!
- Special inspections have to be accomplished:
periodic pressure tests, tightness tests etc.
- The safety regulations of the German biogas association are valid only in some extent.

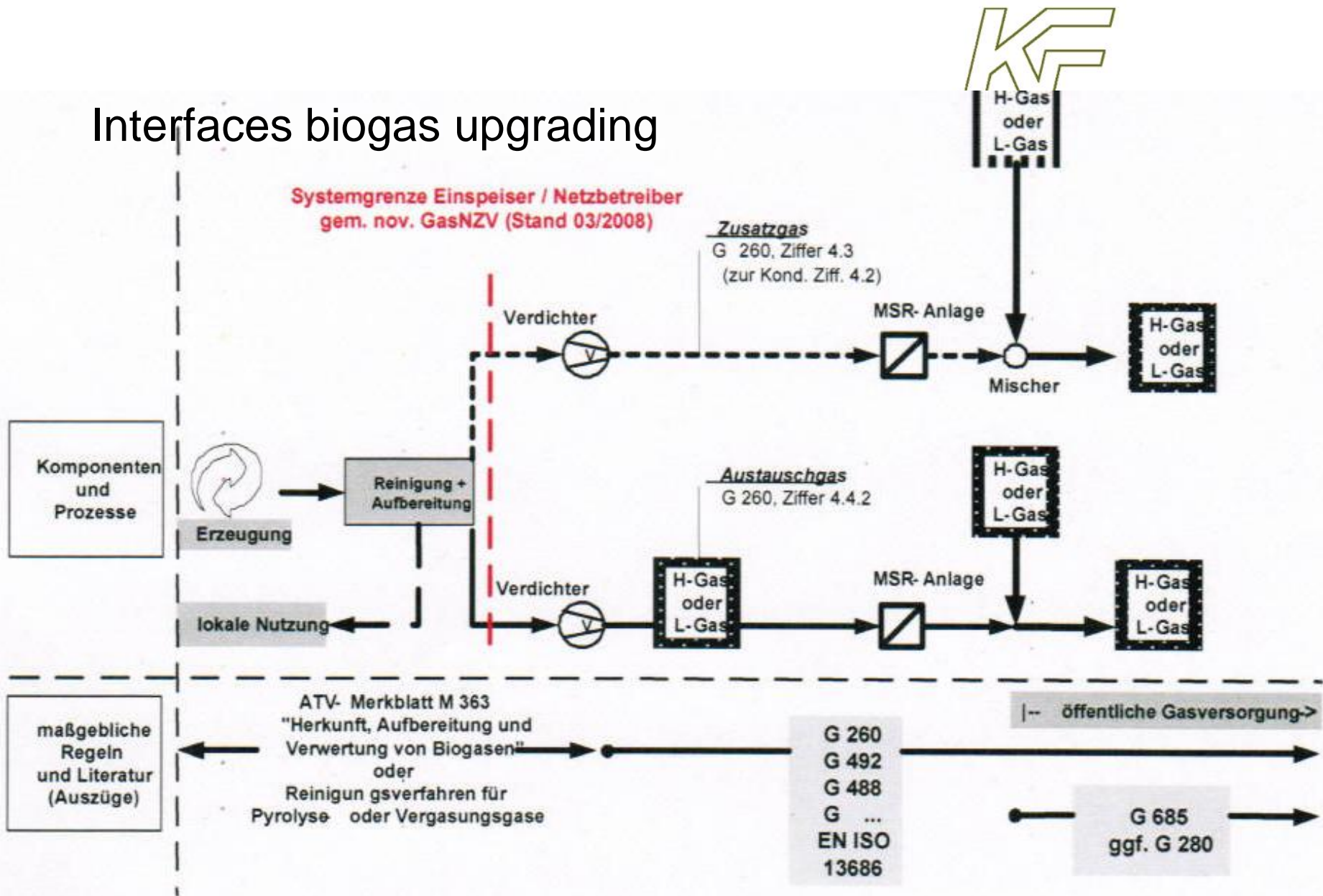
Biogas Upgrading with Participation of K&F



- Stadtwerke Magdeburg (study in 1997)
- Werlte only biogas plant (in operation since 2007)
- Semd (in operation since May 2010)
- Oranienbaum (in detailed engineering)
- Baden-Württemberg (in pre planning)
- Suiker Unie (in detailed engineering)
- Wietzendorf (in approval procedure)
- Zellertal (in approval procedure)

Werlte,
Germany



3rd biogas plant with upgrading
system in Germany



Krieg & Fischer Ingenieure GmbH

- Built: 2002
- Input:
manure 90,000 m³/a,
fats 20,000 m³/a
- Digester 2 x 3,200 m³
steel tank
- CHP: 2 x 1,3 MW_e gas
engine
- Upgrading of biogas
since 2007, PSA
(Carbotech); 350 m³/h
bio methane
- Injection to the local
distribution net
(0,8 bar)

Werlte, Germany

	Amount 2008	Amount 2009
Biogas	2,345,300 m ³	3,597,000 m ³
Bio methane	1,641,800 m ³	2,518,000 m ³
Operation hours	6,800 h	7,194 h

- Gas grid: during warmer days the injection had to be reduced, the local gas grid was overfilled.
- PSA: 2008: 46 days with problems
In July and November problems with the electric occurred that could not be managed ad hoc.
- Biogas plant 2009: because of high H₂S concentration in the biogas, the upgrading plant was switched off for a week.

Semd, Germany



- Built: 2009
- Input:
corn silage 13,800 t/a
- Digester 2,300 m³
concrete tank
- Full stream separation
- Upgrading of
340-360 m³/h biogas
by water scrubbing

Semd, Germany

	Amount
Biogas	2,700,000 m ³ /a
Bio methane	1,350,000 m ³ /a

- Biogas upgrading by water scrubbing
- Biogas plant is in operation since May 2010
 - Problems with programming and sensing
 - Problems with the upgrading system: the promised amount of bio methane has not been produced up to now
 - Failed acceptance test (Leistungsfahrt) so far
 - No acceptance procedure (Abnahme) yet

Wietzendorf, Germany



Krieg & Fischer Ingenieure GmbH



- Built: 2000-2002 as 8,3 MW-plant using waste starch production
- Since 2009 planning of modification (energy-crops only) with:
- Biogas upgrading by water scrubbing
- Injection of bio-methane in 80 bar pipe
- Treatment of digestate
- Heating with digestate pellets and waste heat

Wietzendorf, Germany

	Amount
Biogas	20,600,000 m ³ /a
Bio methane	10,300,000 m ³ /a

- Biogas upgrading by water scrubbing
- Reconstruction of a biogas plant.
- Problems with permission
- Long lasting negotiations with the grid owner, because of missing experience with high amounts of gas:
local grid has not enough capacity
next grid (another owner) with 80 bar has to be used

Oranienbaum, Germany

- Planning: 2010
- Input: energy crops
- 2 digester: 4,954 m³ steel tank each
- Biogas upgrading

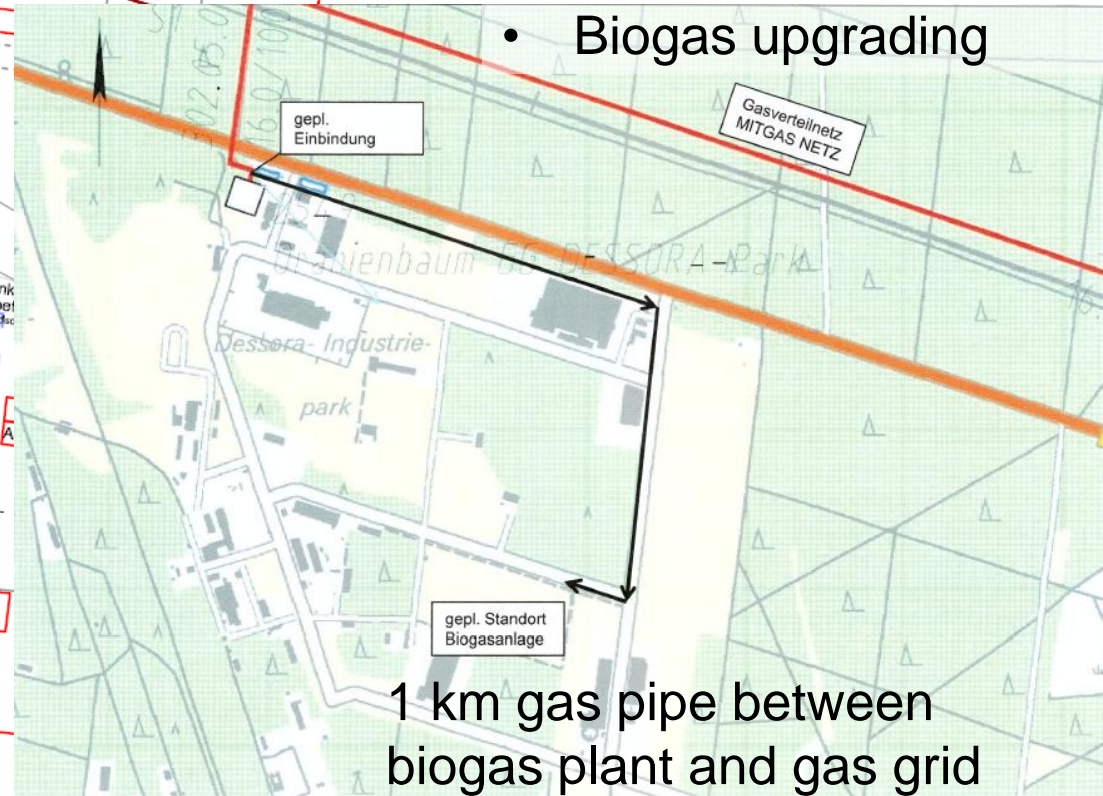

1 km gas pipe between biogas plant and gas grid

Oranienbaum, Germany

	Amount
Biogas	10,700,000 m ³ /a
Bio methane	5,350,000 m ³ /a

- Next gas grid access in a distance of 1 km
- The grid owner has to pay 75% of the costs and has to do the engineering
- The operator has to pay 25% of the costs

Final Conference – Project BIORETE

- The German Experience on Bio methane Grid injection -

Torsten Fischer and Dr Katharina Backes

Krieg & Fischer Ingenieure GmbH
Bertha-von-Suttner-Strasse 9, 37085 Göttingen
Tel.: +49 551 900 363-0, Fax: +49 551 900 363-29
Fischer@KriegFischer.de
www.KriegFischer.de

Milan, November 17, 2010